

## Weighing terminals Terminal and platform combinations

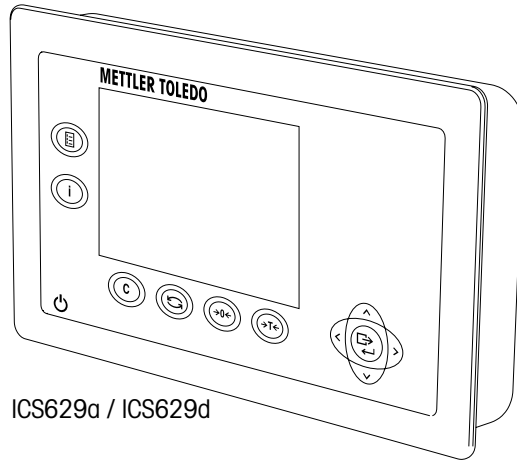

ICS629a / ICS629d

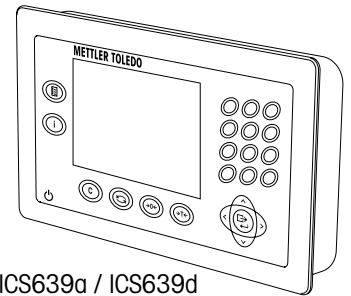

ICS639a / ICS639d

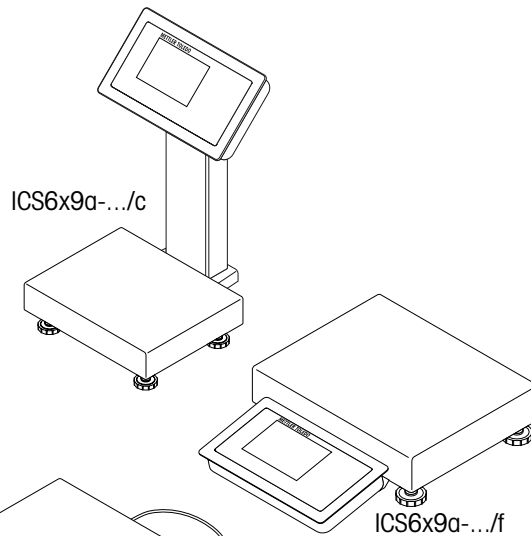

ICS6x9a-.../c

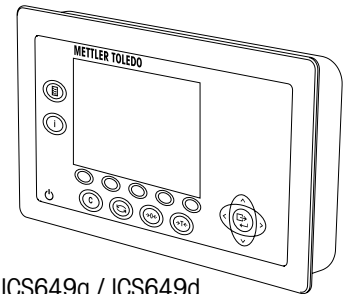

ICS649a / ICS649d

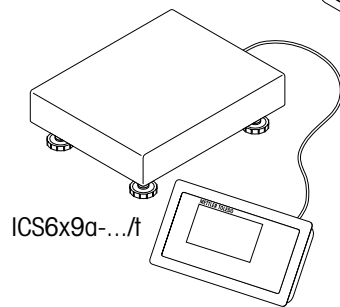

ICS6x9a-.../f

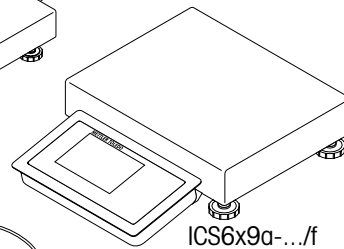

ICS6x9a-.../f

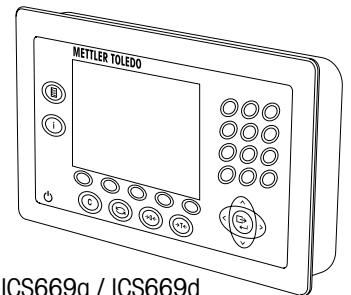

ICS669a / ICS669d

# ServiceXXL

## Tailored Services

Congratulations on choosing the quality and precision of METTLER TOLEDO. Proper use according to these instructions and regular calibration and maintenance by our factory-trained service team ensure dependable and accurate operation to protect your investment. Contact us about a ServiceXXL agreement tailored to your needs and budget.

We invite you to register your product at

[www.mt.com/productregistration](http://www.mt.com/productregistration)

so we can contact you about enhancements, updates and important notifications concerning your METTLER TOLEDO product.

# 1 Safety instructions



## General

- ▲ Do not use the device in a hazardous environment. Special devices are available in our range of products for hazardous environments.
- ▲ The safety of the device cannot be ensured if it is not operated in accordance with these operating instructions.
- ▲ Only authorised personnel may open the device.



## Devices with built-in power supply unit

- ▲ Ensure that the power socket outlet for the device is earthed and easily accessible, so that it can be de-energised rapidly in emergencies.
- ▲ Ensure that the supply voltage at the installation site lies within the range of 100 V to 240 V.
- ▲ Check the power cable regularly for damage. If it is damaged, immediately disconnect the device from the power supply.
- ▲ Ensure that there is a space of at least 3 cm (1.25") at the rear in order to prevent the power cable from being bent too strongly.



## Devices with built-in storage battery

- ▲ Do not use the battery charger in humid or dusty rooms or below 0 °C (32 °F) ambient temperature.
- ▲ After the built-in storage battery has been charged, the cover cap of the charging socket at the device must be closed.



## Terminal and platform combinations

- ▲ The maximum static safe load must never be exceeded. Observe the operation limits, see Technical data.

# 2 Documentation



In addition to this printed Quick Guide you are supplied a CD-ROM with the following contents:

- User manuals
- Installation information
- Mounting instructions
- Data sheets
- Additional information
- Software
- Videos
- Brochures

### 3 Operation

The following illustrations are arranged in two columns:

- left side state of the scale or keystroke
- right side corresponding display

#### 3.1 Switching on/off

##### Switching on

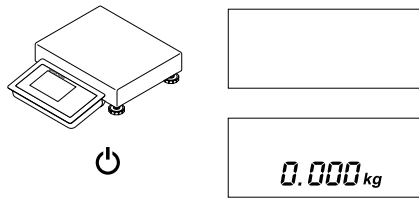

##### Switching off

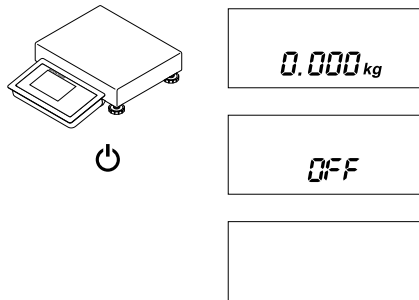

Press and hold the key until OFF is displayed.

#### 3.2 Zeroing

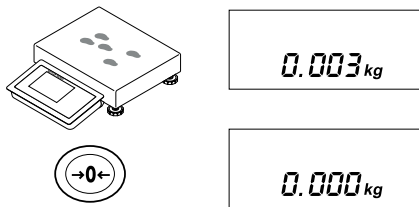

Zeroing corrects the influence of slight changes on the load plate or minor deviations from the zero point.

#### 3.3 Straight weighing

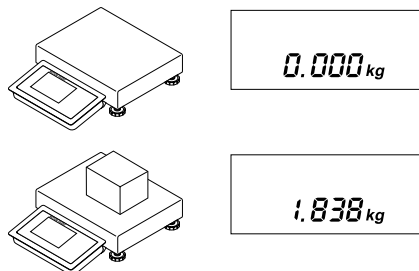

### 3.4

### Taring

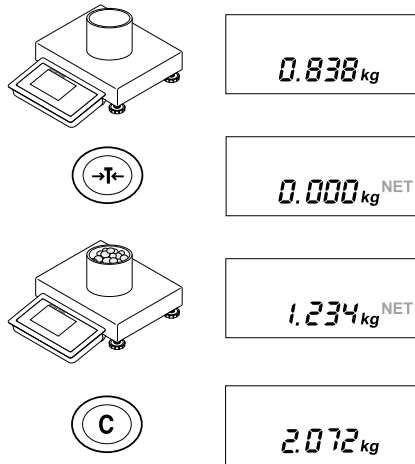

When the scale is tared, the NET symbol is displayed.

When the tare is cleared, the gross weight is displayed.

### 3.5

### Printing or transferring data

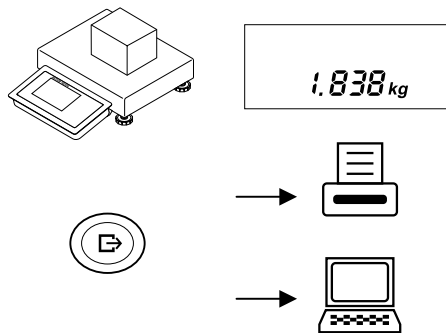

### 3.6

### Switching weight unit

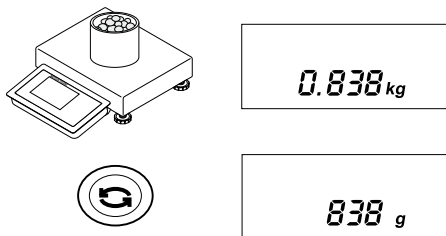

## 4 Cleaning



### Risk of electric shock

- ▲ Before cleaning, unplug the power plug in order to disconnect the terminal from the power supply.
  - ▲ Cover open connectors with cap plugs.
- Clean the protective cover separately. The protective hood is dishwasher-safe.
  - Replace the protective hood regularly.
  - Take off the load plate and remove any dirt and foreign substances which may have collected underneath. Do not use any hard objects to do so.
  - Do not disassemble the weighing device.
  - Remove any possibly remaining detergent by rinsing with clear water.
  - To prolong the lifetime of the load cell, dry it with a soft lint-free cloth immediately after cleaning.
  - Observe all the existing regulations on cleaning intervals and permissible cleaning agents.

### Cleaning of different weighing platforms as described in this Quick Guide

- Make sure to observe the cleaning instructions for the connected weighing platform. The weighing platform may not be designed for wet environments and the cleaning procedures described above.

For more details on the recommended cleaning procedure and cleaning detergents refer to the User manual.

## 5 Disposal



In conformance with the European Directive 2002/96 EC on Waste Electrical and Electronic Equipment (WEEE), this device may not be disposed of with domestic waste. This also applies to countries outside the EU, according to their specific requirements.

Please dispose of this product in accordance with local regulations at the collecting point specified for electrical and electronic equipment.

If you have any questions, please contact the responsible authority or the distributor from which you purchased this device.

Should this device be passed on to other parties (for private or professional use), the content of this regulation must also be related.

Thank you for your contribution to environmental protection.

# Documentation CD-ROM

**To protect your METTLER TOLEDO  
product's future:**

METTLER TOLEDO Service XXL assures  
the quality, measuring accuracy and  
preservation of value of all METTLER  
TOLEDO products for years to come.

Please send for full details about our  
attractive terms of service.  
Thank you.

[www.mt.com/service](http://www.mt.com/service)

For more information

**Mettler-Toledo (Albstadt) GmbH**

D-72458 Albstadt  
Tel. +49 7431-14 0  
Fax +49 7431-14 232

Subject to technical changes  
© 12/2010 Mettler-Toledo (Albstadt) GmbH  
Printed in Germany  
Order number 22021193A



\* 2 2 0 2 1 1 9 3 A \*