



MINIATURE POWER RELAYS

RN series



RELAYS FOR A WIDE RANGE OF APPLICATIONS

RN series equipped with basic functions

IDEC CORPORATION

User-Friendly Relays Equipped with Basic Functions

DPDT



4PDT



Selection Guide

Variation	Minimum applicable load	LED	No. of Poles	Part No.
Standard	24V DC 10mA	with LED	DPDT	RN2S-NL
			4PDT	RN4S-NL
		without LED	DPDT	RN2S-NF
			4PDT	RN4S-NF



Simple

Relays without excessive features such as LEDs enable cost reduction.

NF



Various Contact Ratings

Contact rating ranges applicable for various loads.

	RN2	RN4
Maximum contact current	5A	3A

NL

NF



Applicable Relay Sockets

Various relays sockets available for different mounting styles.

NL

NF



Push-in terminal
DIN rail mount



Screw terminal



Through-panel
mount



PCB
mount



RN Series Miniature Power Relays

High performance relays with up to 5A (DPDT) contacts.

RN Series

Style	LED	Part No.		Coil Rated Voltage
		DPDT	4PDT	
Standard	Available	RN2S-NL-□	RN4S-NL-□	A24, A115, A220, A230, A240 D12, D24, D48, D110
	Not Available	RN2S-NF-□	RN4S-NF-□	A24, A230, D24

• Specify a coil rated voltage in place of □ in the Part No.

Part No. Structure

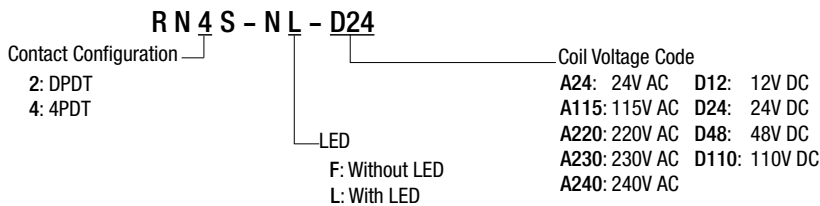

Contact Ratings

Contact	Continuous Current	Allowable Contact Power		Rated Load		
		Resistive Load	Inductive Load	Voltage (V)	Resistive Load (Note)	Inductive Load cos ϕ = 0.4 L/R=7ms
DPDT	5A	1,250VA AC	375VA AC	250 AC	5A	1.5A
		150W DC		30 DC	5A	—
4PDT	3A	750VA AC	250VA AC	250 AC	3A	1A
		90W DC		30 DC	3A	—

Approval Ratings

UL and c-UL Ratings

Voltage	Resistive		General Use	
	RN4S	RN2S	RN4S	RN2S
250V AC	3A	5A	3A	5A
30V DC	3A	5A	—	—

TÜV Ratings

Voltage	Resistive	
	RN4S	RN2S
250V AC	3A	5A
30V DC	3A	5A

Coil Ratings

Rated Voltage (V)	Coil Voltage Code	Rated Current (mA) $\pm 10\%$ (110V or more, $\pm 15\%$) (Reference Value)				Coil Resistance (Ω) $\pm 10\%$ (110V or more, $\pm 15\%$) at 20°C		Operating Characteristics (against rated values at 20°C)			Power Consumption
		RN□S-NL		RN□S-NF		RN□S-NL	RN□S-NF	Maximum Continuous Applied Voltage	Minimum Pickup Voltage	Dropout Voltage	
		50 Hz	60 Hz	50 Hz	60 Hz						
AC (50/60 Hz)	24 A24	54.8	47.0	53.8	46.0	180		110% of rated voltage	80% maximum	30% minimum	Approx. 1.2VA
	115 A115	11.7	10.0	—	—	4,430	—				
	220 A220	7.6	6.6	—	—	13,000	—				
	230 A230	6.4	5.9	5.5	5.0	16,500					
	240 A240	6.3	5.6	—	—	18,790	—				
DC	12 D12	71.2		—		180		110% of rated voltage	80% maximum	10% minimum	Approx. 0.9W
	24 D24	42.6		37.5		640					
	48 D48	23.5		—		2,600	—				
	110 D110	13.4		—		13,000	—				

Specifications

Model (Contact)	RN□S-NL, RN□S-NF	
Contact Material	Ag alloy	
Min. applicable load (*1)	24V DC 10mA	
Contact Resistance (*2)	100 mΩ maximum	
Operate Time (*3)	20 ms maximum	
Release Time (*3)	20 ms maximum	
Power Consumption (approx.)	AC: 1.2 VA DC: 0.9 W	
Insulation Resistance	100 MΩ minimum (500V DC megger)	
Dielectric Strength	Between contact and coil	2,000V AC, 1 minute
	Between contacts of the same pole	1,000V AC, 1 minute
	Between contacts of different poles	2,000V AC, 1 minute
Vibration Resistance	Operating extremes	10 to 55 Hz, double amplitude 1.0 mm
	Damage limits	10 to 55 Hz, double amplitude 1.0 mm
Shock Resistance	Operating extremes	10G
Electrical Life	100,000 operations minimum (operation frequency 1,800 operations per hour)	
Mechanical Life	10,000,000 operations minimum (operation frequency 18,000 operations per hour)	
Operating Temperature (*4)	-40 to +70°C (no freezing)	
Operating Humidity	35 to 85% RH (no condensation)	
Weight (approx.)	35g	

Note: Above values are initial values.

*1) Measured at operating frequency of 120 operations/min (failure rate level P, reference value)

*2) Measured using 24V DC, 1A voltage drop method.

*3) Measured at the rated voltage (at 20°C), excluding contact bounce time.

*4) Measured at 100% rated voltage. Refer to the derating curve on page 7.

Applicable Sockets

DIN Rail Mount

Terminal Style	No. of Poles	Part No.	Applicable Spring/Release Lever
Screw	2-pole	SN2S-05D	SFA-502
	4-pole	SN4S-05D	
Finger-safe	2-pole	SM2S-05DF	
	4-pole	SY4S-05DF	
Push-in	2-pole	SU2S-21L	SU9Z-S21R
	4-pole	SU4S-21L	SU9Z-C21R

• See page 8 for details on sockets.

Through-Panel Mount / PCB Mount

Mounting Style	No. of Poles	Part No.	Applicable Spring/Release Lever	
Through-panel mount	2-pole	SM2S-51	SFA-301	
			SFA-302	
			SY4S-51F1	
PCB mount		SM2S-61	SFA-301	
			SFA-302	
			SY4S-51F1	
Through-panel mount	4-pole	SM2S-62	SY4S-51F1	
			SFA-504	
			SFA-301	
Through-panel mount		4-pole	SY4S-51	SFA-302
				SY4S-51F1
				SFA-301
PCB mount	SY4S-61		SFA-302	
			SY4S-51F1	
			SFA-504	
Through-panel mount	4-pole	SY4S-62	SFA-504	
			SY4S-51F1	
			SFA-301	

• For details on SM, and SY sockets, see each catalog.

Dimensions

All dimensions in mm

RN2S-NL, RN2S-NF
(DPDT)

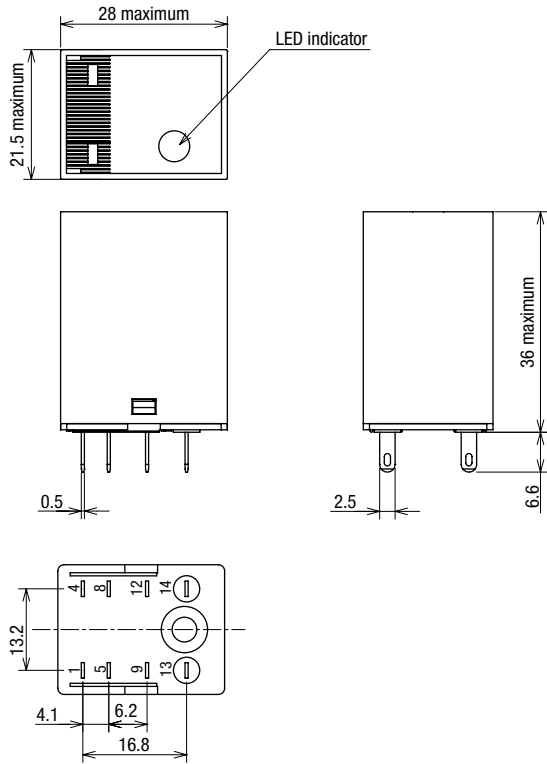

RN4S-NL, RN4S-NF
(4PDT)

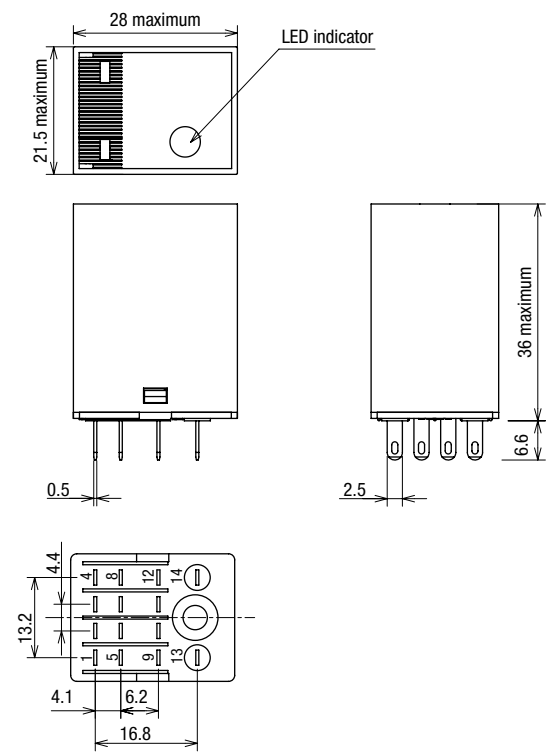

Internal Connection (Bottom View)

All dimensions in mm

RN2S-NL (With LED)
(DPDT)

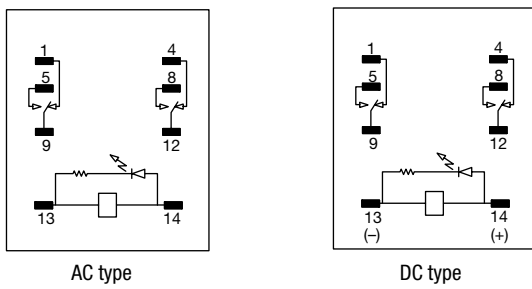

RN4S-NL (With LED)
(4PDT)

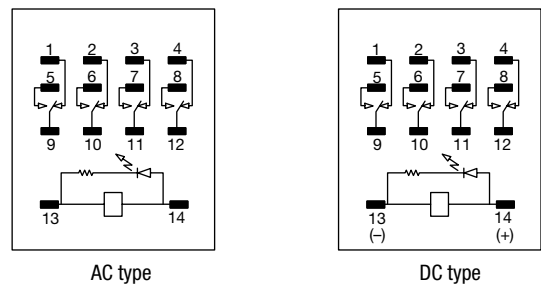

RN2S-NF (Without LED)
(DPDT)

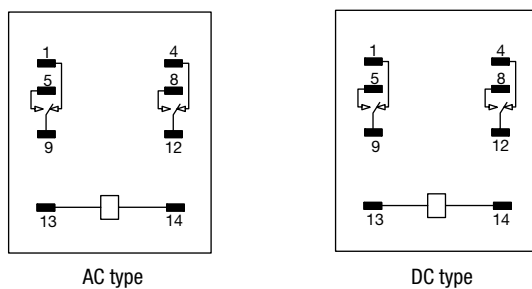

RN4S-NF (Without LED)
(4PDT)

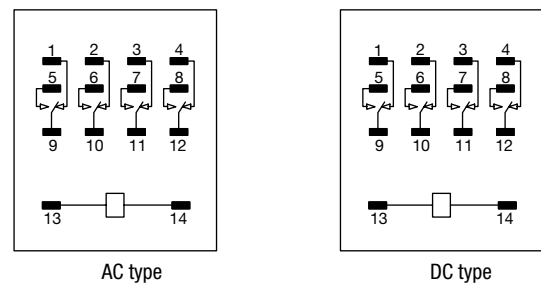

Characteristics (Reference Data)

Electrical Life Curve

RN2S-NL, RN2S-NF (DPDT)

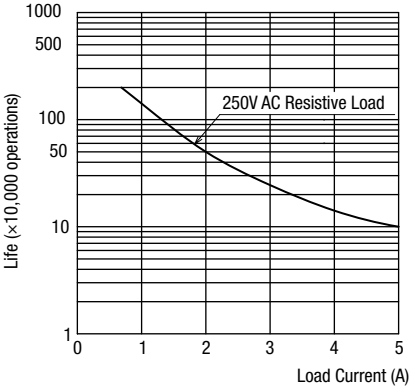

RN4S-NL, RN4S-NF (4PDT)

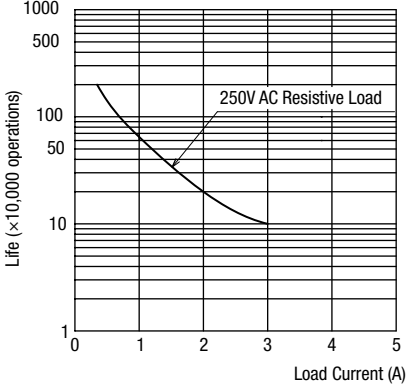

Derating Curve

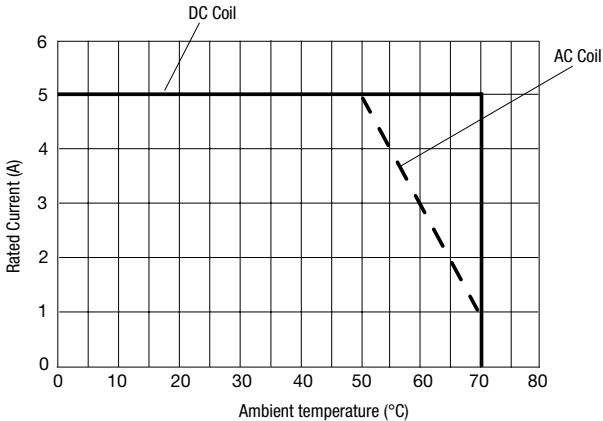

RN2S-NL, RN2S-NF



Push-in relay sockets reduce wiring time by 55%*

* Compared with conventional screw terminal relay sockets.

Relay Sockets

Shape		
No. of Poles	2-pole	4-pole
Part No.	SU2S-21L	SU4S-21L

Specifications and Ratings

Part No.	SU2S-21L	SU4S-21L
No. of Poles	2	4
Rated Insulation Voltage	300V AC/DC	
Rated Thermal Current (*1)	12A	8A
Applicable Wire	Solid wire / stranded wire: 0.14 to 1.5mm ² , AWG26 to 16 Stranded wire with ferrule (without insulated cover): 0.5 to 1.5mm ² , AWG20 to 16 Stranded wire with ferrule (with insulated cover): 0.14 to 1.0mm ² , AWG26 to 18	
Insulation Resistance	100MΩ min. (500V DC megger)	
Dielectric Strength	2500V AC, 1 min. (between live and dead metal parts, between live metal parts of the different poles)	
Vibration Resistance (Damage Limits)	10 to 55 Hz, amplitude 1.0 mm	
Shock Resistance (Damage Limits)	50G (when using SU9Z-S21R/-S21T hold-down spring or SU9Z-C21R release lever)	
Operating Temperature	-40 to +65°C (no freezing)	
Operating Humidity	5 to 85% RH (no condensation)	
Storage Temperature	-40 to +65°C (no freezing)	
Storage Humidity	5 to 85% RH (no condensation)	
Degree of Protection	IP20 (IEC 60529)	
Weight (approx.)	80g	
Applicable Standards	UL508, CSA C22.2 No.14, IEC61984	

*1) Be sure to note the derating characteristics.

• For instructions on SU series, see EP1720 SU series Relay Sockets catalog.

Derating Curve

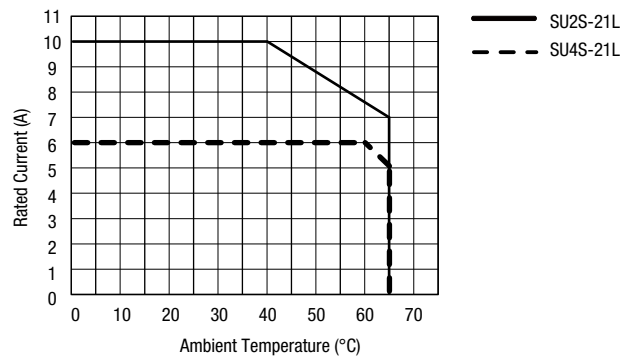

Applicable Relay

No. of Poles	Socket	Relay
2	SU2S-21L	RU2S, RN2S
4	SU4S-21L	RU4S, RU42S, RN4S

• For details on RU series relay, and RN series relay, see catalog.

• When using the SU socket with RU series relay, be sure to note the derating characteristics.

Dimensions

SU2S-21L

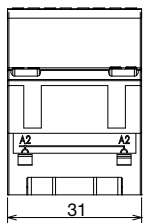
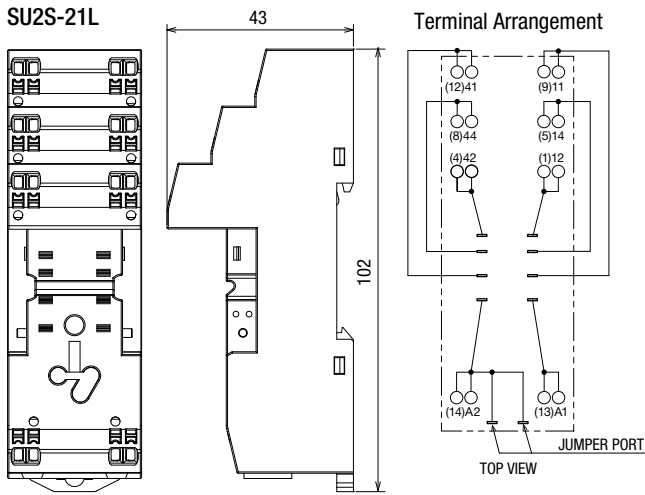

SU4S-21L

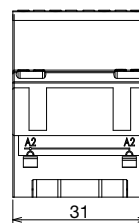
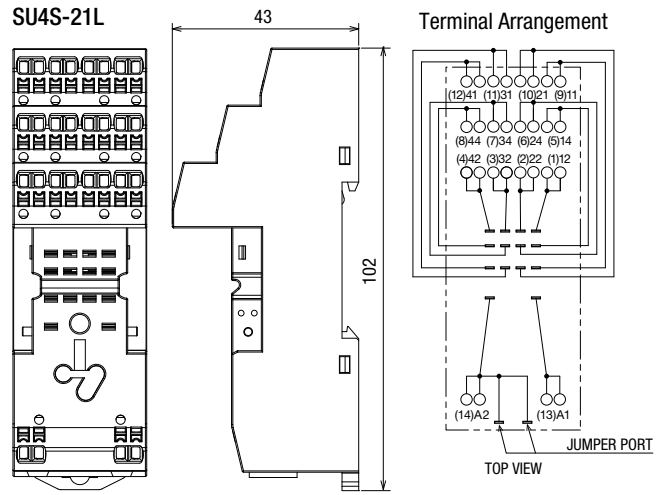

All dimensions in mm.

Note) The numbers in parentheses () are values according to NEMA standards.



Accessories

When ordering, specify the Ordering No.

Function	Shape	Material	Part No.	Ordering No.	Package Quantity	Remarks
Release Lever (For Relay)		Plastic	SU9Z-C21R	SU9Z-C21R	5	<p>Note) Release lever cannot be used on timers.</p>
Marking Plate		Plastic (white)	SU9Z-P2100W	SU9Z-P2100W	10	
Jumper		Bronze (tin-plated) Insulation: PBT plastic	SU9Z-J2102A	SU9Z-J2102A	10	A2 terminal of the coil is connected. The rated current is 2A.
Hold-down Spring	For Relay	Stainless steel	SU9Z-S21R	SU9Z-S21R	10	
DIN Rail		Aluminum	BAA1000	BAA1000PN10	10	<ul style="list-style-type: none"> Length: 1m Width: 35mm Weight: 200g (approx.) (Can also be used on SN series sockets)
End Clip		Metal (zinc-plated steel)	BNL6	BNL6PN10	10	Weight: 15g (approx.) Use end clips when mounting multiple sockets on the DIN rail. (Can also be used on SN series sockets)
DIN Rail Spacer		Plastic (black)	SA-406B	SA-406B	1	Thickness: 5 mm Used for adjusting spacing between sockets mounted on a DIN rail. (Can also be used on SN series sockets)

SN Series Sockets

SN Series

Shape		
No. of Poles	2-pole	4-pole
Part No.	SN2S-05D	SN4S-05D

Specifications

Model	SN2S-05D	SN4S-05D
Rated Current	10A	6A
Rated Insulation Voltage	300V	
Applicable Wire	0.5 to 2.5mm ²	
Applicable Crimping Terminal	1.25mm ² ×2	
Recommended Tightening Torque	0.8N·m	
Screw Terminal Style	M3 slotted Phillips screw	
Insulation Resistance	100MΩ minimum (500V DC megger)	
Dielectric Strength	2,000V AC, 1 minute	
Vibration Resistance	10 to 55 Hz, amplitude 1.0 mm	
Operating Temperature	SN2S: -40 to +70°C (no freezing) SN4S: -40 to +70°C (no freezing)	
Operating Humidity	35 to 85% RH (no condensation)	
Weight (approx.)	34g	56g
Applicable Standards	UL508, CSA C22.2 No.14, IEC61984	

Derating Curve

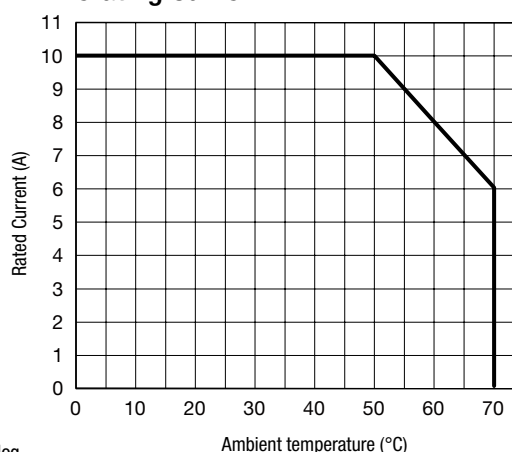

• For instructions on SN series, see EP1688 RN Series Universal Relays / SN Series Sockets catalog.

Applicable Relay

2-pole		4-pole	
Socket	Relay	Socket	Relay
SN2S-05D	RN2S RU2S (Note)	SN4S-05D	RN4S RU4S

• See page 4 for details on RN relays. For details on RU relays, see catalog.

Note) When using the RU2S relay with SN2S socket, be sure to note the derating characteristics.

Dimensions

All dimensions in mm.

DPDT

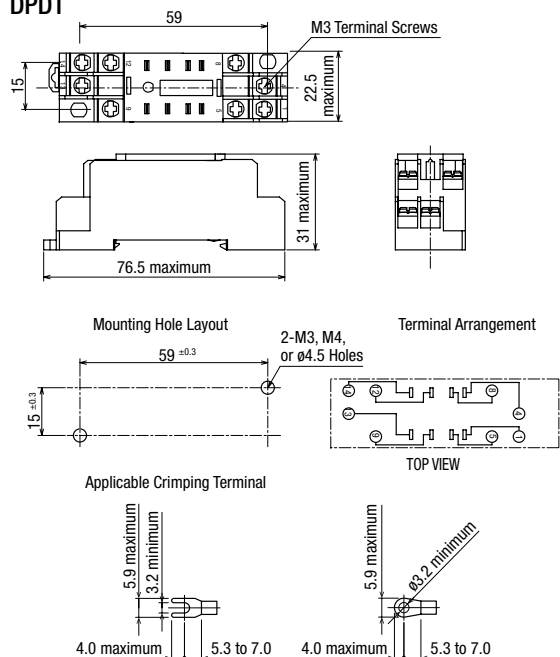

4PDT

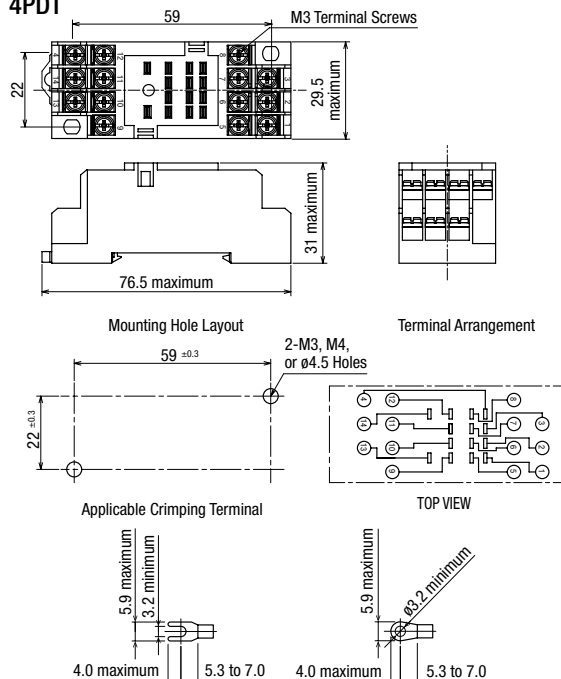

Hold-down Spring

Item	Shape	Part No.	Ordering No.	Package Quantity	Remarks
Wire Spring		SFA-502	SFA-502PN20	20 (10 pairs)	Material: SUS Two leaf springs are used for one relay.

⚠ Safety Precautions

- Turn off the power to the relay before starting installation, removal, wiring, maintenance, and inspection of the relays. Failure to turn power off may cause electrical shock or fire hazard.
- Observe specifications and rated values, otherwise electrical shock or fire hazard may be caused.

Instructions

Driving Circuit for Relays

1. To make sure of correct relay operation, apply rated voltage to the relay coil.
2. Input voltage for the DC coil:

A complete DC voltage is best for the coil power to make sure of stable relay operation. When using a power supply containing a ripple voltage, suppress the ripple factor within 5%. When power is supplied through a rectification circuit, the relay operating characteristics, such as pickup voltage and dropout voltage, depend on the ripple factor. Connect a smoothing capacitor for better operating characteristics as shown below.

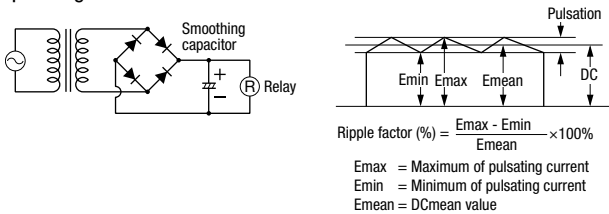

3. Operating the relay in synchronism with AC load:
If the relay operates in synchronism with the AC power voltage of the load, the relay life may be reduced. If this is the case, select a relay in consideration of the required reliability for the load. Or, make the relay turn on and off irrespective of the AC power phase or near the point where the AC phase crosses zero voltage.

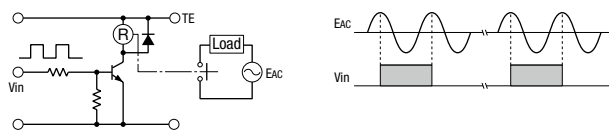

4. Leakage current while relay is off:
When driving an element at the same time as the relay operation, a special consideration is needed for the circuit design. As shown in the incorrect circuit below, Leakage current (I_o) flows through the relay coil while the relay is off. Leakage current causes the coil release failure or adversely affects the vibration resistance and shock resistance. Design a circuit as shown in the correct example.

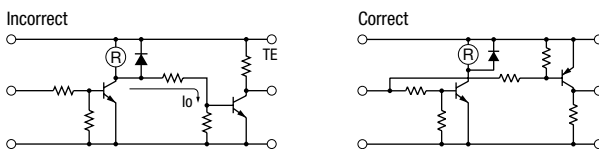

5. Surge suppression for transistor driving circuits:
When the relay coil is turned off, a high-voltage pulse is generated, causing the transistor to deteriorate and sometimes to break. Be sure to connect a diode to suppress the counter electromotive force. Then, the coil release time becomes slightly longer. To shorten the coil release time, connect a Zener diode between the collector and emitter of the transistor. Select a Zener diode with a Zener voltage slightly higher than the power voltage.

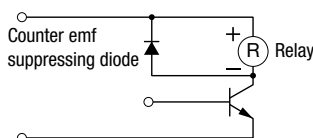

- Use wires of the proper size to meet the voltage and current requirements. Tighten the terminal screws on the relay socket to the proper tightening torque.

6. The coil terminal of the DC relay has polarity. Connect terminals according to the internal connection diagram. Incorrect wiring may cause malfunction.

Protection for Relay Contacts

1. The contact ratings show maximum values. Make sure that these values are not exceeded. When an inrush current flows through the load, the contact may become welded. If this is the case, connect a contact protection circuit, such as a current limiting resistor.
2. Contact protection circuit:

When switching an inductive load, arcing causes carbides to form on the contacts, resulting in an increased contact resistance. In consideration of contact reliability, contact life, and noise suppression, use of a surge absorbing circuit is recommended. Note that the release time of the load becomes slightly longer. Check the operation using the actual load. Incorrect use of a contact protection circuit will adversely affect switching characteristics. Four typical examples of contact protection circuits are shown in the following table:

RC		This protection circuit can be used when the load impedance is smaller than the RC impedance in an AC load power circuit. R: Resistor of approximately the same resistance value as the load C: 0.1 to 1 μ F
		This protection circuit can be used for both AC and DC load power circuits. R: Resistor of approximately the same resistance value as the load C: 0.1 to 1 μ F
Varistor		This protection circuit can be used for both AC and DC load power circuits. For a best result, when using on a power voltage of 24 to 48V AC/DC, connect a varistor across the load. When using on a power voltage of 100 to 240V AC/DC, connect a varistor across the contacts.

3. Do not use a contact protection circuit as shown below:

	This protection circuit is very effective in arc suppression when opening the contacts. But, the capacitor is charged while the contacts are opened. When the contacts are closed, the capacitor is discharged through the contacts, increasing the possibility of contact welding.
	This protection circuit is very effective in arc suppression when opening the contacts. But, when the contacts are closed, a current flows to charge the capacitor, causing contact welding.

Ordering Terms and Conditions

Thank you for using IDEC Products.

By purchasing products listed in our catalogs, datasheets, and the like (hereinafter referred to as "Catalogs") you agree to be bound by these terms and conditions. Please read and agree to the terms and conditions before placing your order.

1. Notes on contents of Catalogs

- (1) Rated values, performance values, and specification values of IDEC products listed in this Catalog are values acquired under respective conditions in independent testing, and do not guarantee values gained in combined conditions.
Also, durability varies depending on the usage environment and usage conditions.
- (2) Reference data and reference values listed in Catalogs are for reference purposes only, and do not guarantee that the product will always operate appropriately in that range.
- (3) The specifications / appearance and accessories of IDEC products listed in Catalogs are subject to change or termination of sales without notice, for improvement or other reasons.
- (4) The content of Catalogs is subject to change without notice.

2. Note on applications

- (1) If using IDEC products in combination with other products, confirm the applicable laws / regulations and standards.
Also, confirm that IDEC products are compatible with your systems, machines, devices, and the like by using under the actual conditions. IDEC shall bear no liability whatsoever regarding the compatibility with IDEC products.
- (2) The usage examples and application examples listed in Catalogs are for reference purposes only. Therefore, when introducing a product, confirm the performance and safety of the instruments, devices, and the like before use. Furthermore, regarding these examples, IDEC does not grant license to use IDEC products to you, and IDEC offers no warranties regarding the ownership of intellectual property rights or non-infringement upon the intellectual property rights of third parties.
- (3) When using IDEC products, be cautious when implementing the following.
 - i. Use of IDEC products with sufficient allowance for rating and performance
 - ii. Safety design, including redundant design and malfunction prevention design that prevents other danger and damage even in the event that an IDEC product fails
 - iii. Wiring and installation that ensures the IDEC product used in your system, machine, device, or the like can perform and function according to its specifications
- (4) Continuing to use an IDEC product even after the performance has deteriorated can result in abnormal heat, smoke, fires, and the like due to insulation deterioration or the like. Perform periodic maintenance for IDEC products and the systems, machines, devices, and the like in which they are used.
- (5) IDEC products are developed and manufactured as general-purpose products for general industrial products. They are not intended for use in the following applications, and in the event that you use an IDEC product for these applications, unless otherwise agreed upon between you and IDEC, IDEC shall provide no guarantees whatsoever regarding IDEC products.
 - i. Use in applications that require a high degree of safety, including nuclear power control equipment, transportation equipment (railroads / airplanes / ships / vehicles / vehicle instruments, etc.), equipment for use in outer space, elevating equipment, medical instruments, safety devices, or any other equipment, instruments, or the like that could endanger life or human health
 - ii. Use in applications that require a high degree of reliability, such as provision systems for gas / waterworks / electricity, etc., systems that operate continuously for 24 hours, and settlement systems
 - iii. Use in applications where the product may be handled or used deviating from the specifications or conditions / environment listed in the Catalogs, such as equipment used outdoors or applications in environments subject to chemical pollution or electromagnetic interference
If you would like to use IDEC products in the above applications, be sure to consult with an IDEC sales representative.

3. Inspections

We ask that you implement inspections for IDEC products you purchase without delay, as well as thoroughly keep in mind management/maintenance regarding handling of the product before and during the inspection.

4. Warranty

(1) Warranty period

The warranty period for IDEC products shall be one (1) year after purchase or delivery to the specified location. However, this shall not apply in cases where there is a different specification in the Catalogs or there is another agreement in place between you and IDEC.

(2) Warranty scope

Should a failure occur in an IDEC product during the above warranty period for reasons attributable to IDEC, then IDEC shall replace or repair that product, free of charge, at the purchase location / delivery location of the product, or an IDEC service base. However, failures caused by the following reasons shall be deemed outside the scope of this warranty.

- i. The product was handled or used deviating from the conditions / environment listed in the Catalogs
- ii. The failure was caused by reasons other than an IDEC product
- iii. Modification or repair was performed by a party other than IDEC
- iv. The failure was caused by a software program of a party other than IDEC
- v. The product was used outside of its original purpose
- vi. Replacement of maintenance parts, installation of accessories, or the like was not performed properly in accordance with the user's manual and Catalogs
- vii. The failure could not have been predicted with the scientific and technical standards at the time when the product was shipped from IDEC.
- viii. The failure was due to other causes not attributable to IDEC (including cases of force majeure such as natural disasters and other disasters)

Furthermore, the warranty described here refers to a warranty on the IDEC product as a unit, and damages induced by the failure of an IDEC product are excluded from this warranty.

5. Limitation of liability

The warranty listed in this Agreement is the full and complete warranty for IDEC products, and IDEC shall bear no liability whatsoever regarding special damages, indirect damages, incidental damages, or passive damages that occurred due to an IDEC product.

6. Service scope

The prices of IDEC products do not include the cost of services, such as dispatching technicians. Therefore, separate fees are required in the following cases.

- (1) Instructions for installation / adjustment and accompaniment at test operation (including creating application software and testing operation, etc.)
- (2) Maintenance inspections, adjustments, and repairs
- (3) Technical instructions and technical training
- (4) Product tests or inspections specified by you

The above content assumes transactions and usage within your region. Please consult with an IDEC sales representative regarding transactions and usage outside of your region. Also, IDEC provides no guarantees whatsoever regarding IDEC products sold outside your region.

IDEC CORPORATION

Head Office

6-64, Nishi-Miyahara-2-Chome, Yodogawa-ku, Osaka 532-0004, Japan

USA	IDEC Corporation	Tel: +1-408-747-0550	opencontact@idec.com
Germany	APEM GmbH	Tel: +49-40-25 30 54-0	service@eu.idec.com
Singapore	IDEC Izumi Asia Pte. Ltd.	Tel: +65-6746-1155	info@sg.idec.com
Thailand	IDEC Asia (Thailand) Co., Ltd	Tel: +66-2-392-9765	sales@th.idec.com
India	IDEC Controls India Private Limited	Tel: +91-80679-35328	info_india@idec.com
Taiwan	IDEC Taiwan Corporation	Tel: +886-2-2577-6938	service@tw.idec.com

Hong Kong	IDEC Izumi (H.K.) Co., Ltd.	Tel: +852-2803-8989	info@hk.idec.com
China	IDEC (Shanghai) Corporation	Tel: +86-21-6135-1515	idec@cn.idec.com
	Beijing Branch	Tel: +86-10-6581-6131	idec@cn.idec.com
	Guangzhou Branch	Tel: +86-20-8362-2394	idec@cn.idec.com
Japan	IDEC Corporation	Tel: +81-6-6398-2527	jp_marketing@idec.com

 www.idec.com