

INGESCO LIGHTNING SOLUTIONS



EXTERNAL LIGHTNING PROTECTION

GROUNDING SYSTEMS

CONTROL SYSTEMS

SURGE ARRESTORS

STORM DETECTOR

P R O D U C T S A N D S E R V I C E S . 2 0 2 2



INGESCO LIGHTNING SOLUTIONS

TABLE OF CONTENTS

EXTERNAL LIGHTNING PROTECTION	07-46
GROUNDING SYSTEMS	47-64
CONTROL SYSTEMS	65-72
SURGE ARRESTORS	73-86
STORM DETECTOR	87-92
INDEX	95-104

ACTIVE RODS: PDC (ESE) LIGHTNING RODS

standards

Implementing rules for an effective person and property protection system:

- **UNE 21186:2011:** Lightning protection - Lightning rods with priming device.
- **NF C 17-102:2011:** Early streamer emission lightning protection systems.
- **NP 4426:2013:** Lightning protection - systems with non-radioactive ionization device.

In addition to these, there may be legislation or rules of each country that must be taken into account.

risk index calculation

Annex A (risk analysis) of the UNE 21186: 2011 determines the need or not to install external lightning protection and the level of protection applied to reduce the risk of damage caused by lightning.

INGESCO has an online tool which allows the calculation of risk and the implementation of protective measures quickly and easily. Introducing the characteristics of the structure to be protected, geographical location, activity, etc ..., provides protection levels to be applied, and generates a report of the information provided.

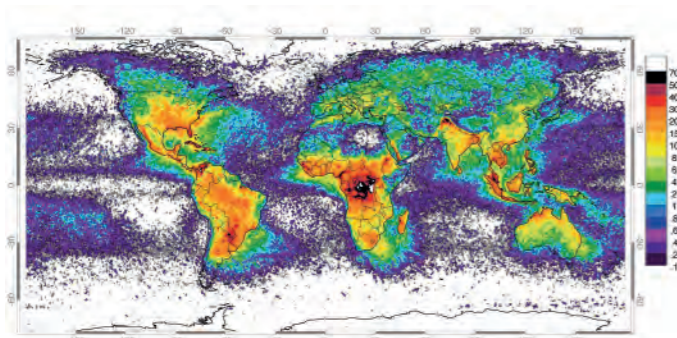

Fig. 1 – Lightning distribution map.



Fig. 2 – <https://calculus.ingesco.com/>

protection radius calculation

Lightning rods with an early steamer emission priming device (ESE), have a protection radius depending on the necessary protective level to be obtained by performing tests in accordance with UNE 21186: 2011 or NF C 17102: 2011, and must be certified by an accredited high voltage laboratory.

Model	PDC 3.1	PDC 3.3	PDC 4.3	PDC 5.3	PDC 6.3	PDC 6.4
Ref.	101000	101001	101003	101005	101008	101009
Δt	15μs	25μs	34μs	43μs	54μs	60μs

Tabla 1 – Early streamer ΔT(μs) INGESCO ESE lightning rods.

UNE 21186: 2011 (paragraph C.2.2) indicates that a ESE lightning rod must obtain an early steamer emission ΔT > 10 μs minimum.

Also, the maximum permissible value is 60μs although tests were obtained with superior results.

The area to be protected by a ESE arrester is delimited by a surface of revolution that is defined by the radius of the corresponding protection to different heights (h) considered, whose axis is the same ESE arrester.

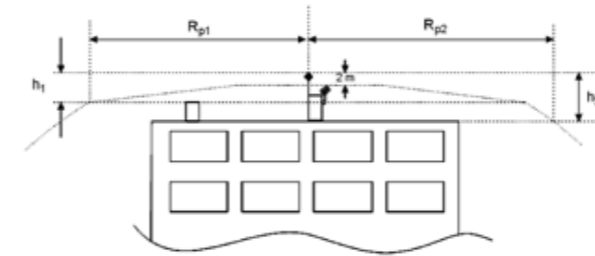

Protection Level	Notional sphere radius (r)
I	20 m
II	30 m
III	45 m
IV	60 m

Table 2 – The rolling sphere radius r based on the level of protection.

a) If $2m \leq h \leq 5m$: $R_p = \frac{h \cdot R_p(5)}{5}$

b) If $h \geq 5m$: $R_p = \sqrt{[(2 \cdot r \cdot h) - (h^2)] + [\Delta \cdot (2 \cdot r + \Delta)]}$

Whereas:

- Rp:** Resulting protection radius.
- r:** The radius of the rolling sphere. Predetermined standard value according to the applicable security level (see Table 2).
- h:** The height from the tip of the ESE to the point where we want to calculate the radius of protection.
- Δ:** Advance arrester priming considered (ΔT) in meters.

example radius protection calculation Rp (model INGESCO PDC 3.1):

To calculate the different radii of protection of a ESE lightning rod, we must know the variables involved in the formulation:

- INGESCO PDC 3.1 model has ΔT=15 μs and thus **Δ=15 m**.
- Apply level II protection, the notional sphere radius corresponds to **r = 30m**.
- Consider the height **h = 20m**.

Each R_{p_n} radii are calculated, for each reference point, using the formula:

$$R_{p_n} = \sqrt{[(2 \cdot r \cdot h_n) - (h_n^2)] + [\Delta \cdot (2 \cdot r + \Delta)]}$$

For the given model the radii are shown in table 3:

h (m)	Radius (m) Level II
2	15
4	30
6	38
10	40
20	43

Table 3 protection radii for an ESE 3.1

The total volume of protection can be represented graphically (See Fig.3).

Once each radius is calculated R_p , verify that the building remains within the lightning rod protection radius (see Fig.4).

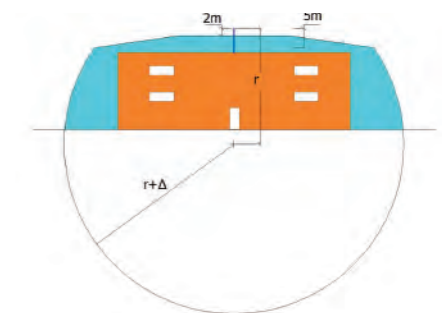

Fig. 3 – Volume protected with ESE lightning rod.



Fig. 4 – ESE protection volume.

PASSIVE SYSTEMS: FRANKLIN RODS – CAPTURE MESHES

standards

In order to design an effective lightning protection system with Franklin rods or capturing meshes, the following rules shall apply:

- IEC 62305:2010 Lightning protection (Parts 1, 2, 3 y 4).
- UNE - EN 62305:2011 Protection against lightning (Parts 1, 2, 3 y 4).
- NFPA 780:2020 Standard for the installation of lightning protection systems.

In addition to these rules, legislation may exist in each country to be taken into account.

risk calculation

INGESCO has an online tool that allows the risk calculation according to IEC 62305 (Part 2), which allows the calculation of risk and the implementation of protective measures quickly and easily (see Fig.2).

calculation methods of the protection zone

Accepted methods for determining the area of passive protection systems according to IEC 62305 (Part 3) are:

Protective angle method

It is best suited method for buildings with simple shapes, although it is limited to a maximum height to the level of protection applied (Fig.5).

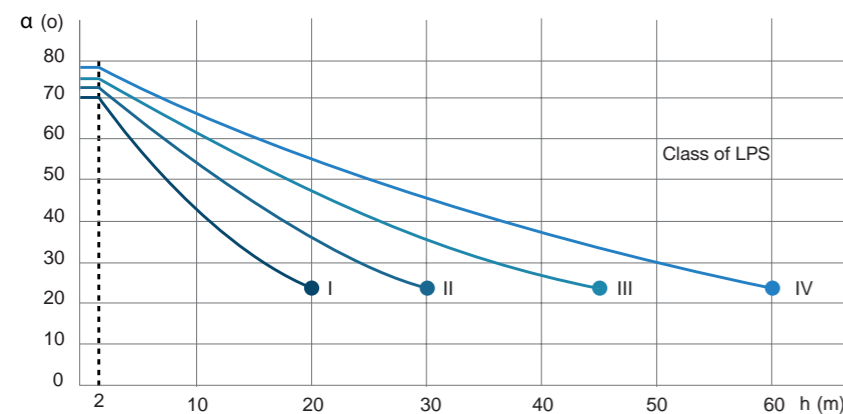

Fig. 5 – Angles corresponding to protection classes of IEC 62305-3 LPS.

The volume of protection resulting from the application of the protection angle method in a termination rod is shown in Fig.6.

Once calculated, the different angles of protection of the termination rods that make up the system verifies that the building is fully protected (Fig 7).

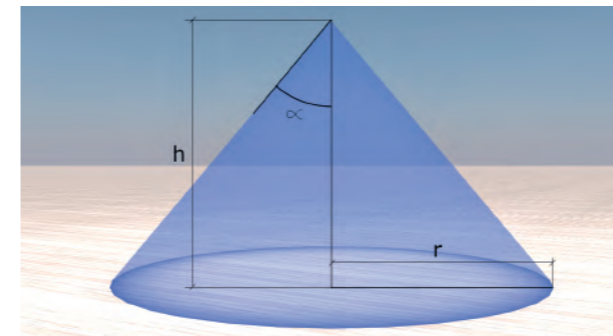

Fig. 6 – Protected volume by a vertical point. IEC 62305-3.

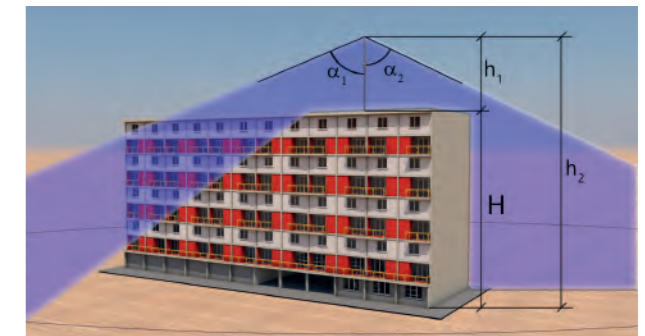

Fig. 7 – Protection volume angles α_1 and α_2 depending on heights h_1 and h_2 .

Rolling sphere method and the mesh method

When a structure has a height higher than indicated in Figure 5, the protection angle method is not applicable. For these cases, IEC 62305-3 indicates to use: **rolling sphere method** (valid for all types of buildings), or **mesh method** (indicated when flat surfaces are protected) (see Fig.9).

Protection method		
Class of LPS	Radius of rolling sphere r (m)	Size of the mesh W_m (m)
I	20	5x5
II	30	10x10
III	45	15x15
IV	60	20x20

Table 4 – Maximum values of rolling sphere and mesh size for each class of LPS.

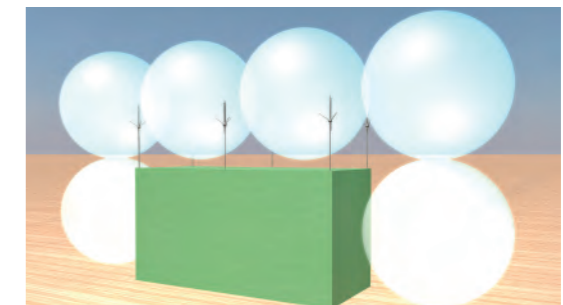

Fig. 8 – Protected volume by the rolling sphere method.

Applying the rolling sphere method. The location of the capture system (point or mesh) is adequate if any point of the protected structure comes into contact with a rolling sphere of radius r (see Table 4).

Taller structures remaining above the Faraday cage should be protected with lightning rods (see Fig. 10).

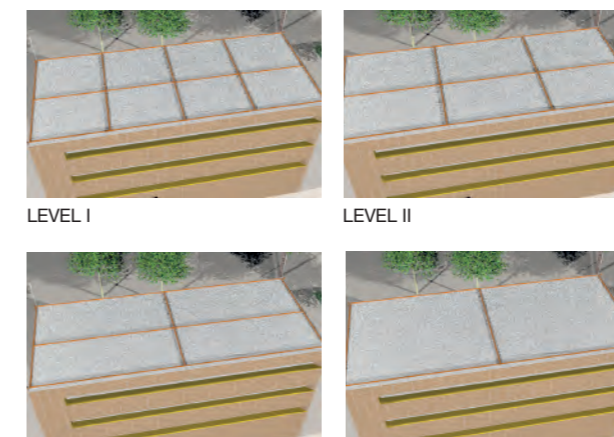

Fig. 9 – Protection grids based on the levels of protection.

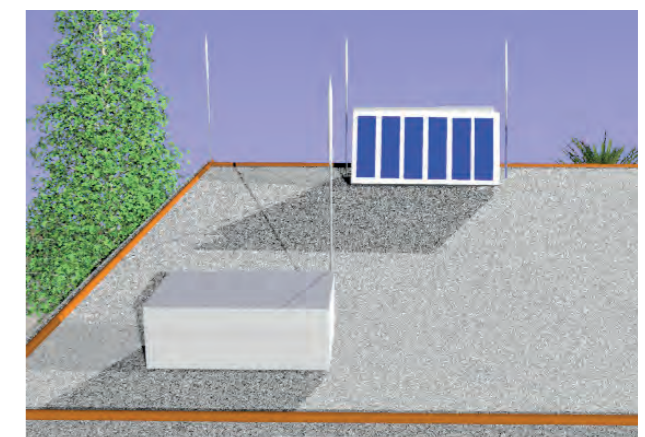

Fig. 10 – Protection of protruding structures with a capture mesh system by lightning rods.

DOWN CONDUCTORS

► ESE down conductors

The down conductors are intended to conduct lightning current from the collection devices to the grounding.

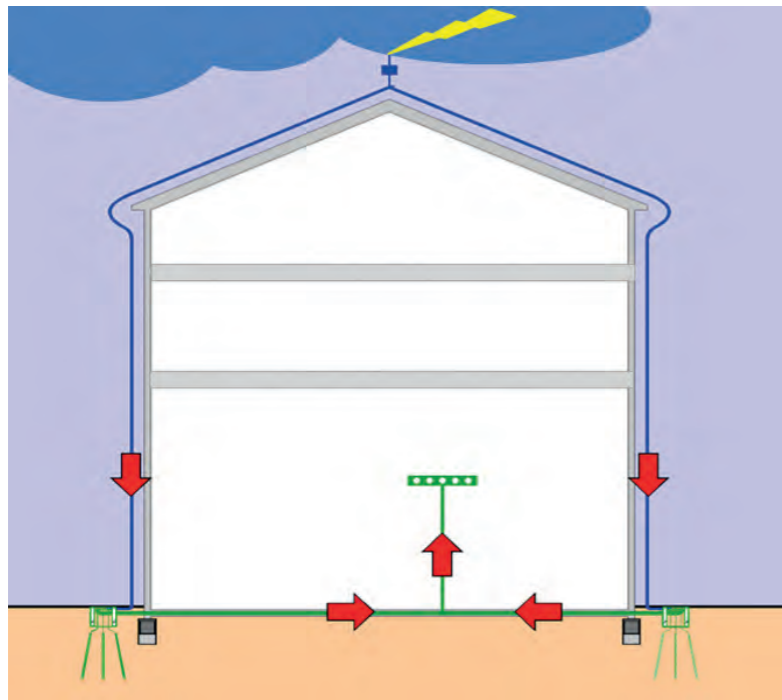

Fig. 11 – Down conductors of LPS by ESE.

The lightning rod is connected to ground with at least two down conductors located on opposite facades whenever possible (Fig.11).

The down conductors must be installed outside the building, avoiding the proximity of electrical cables and gas.

Its path must be as straight as possible, using the shortest path to earth, avoiding any sharp bend or lift.

When several ESEs are installed on the same building they can share down conductors.

Due to the nature of the lightning strike, down conductors should respect the materials and dimensions specified in IEC 62561-2. Those indicated in table 5 are the most recommended materials.

Material	Format	Minimum section mm ²
Copper	Cable	50 (Ø1,7 mm per cable)
Copper	Round	50 (Ø8 mm)
Copper	Tape	50 (Minimum thickness 2 mm)

Table 5 – Material Table IEC 62561-2.

The down conductor ground shall be properly secured and tightened, with reference driver three clips per meter.

Protect the bottom of the down conductor by a protective tube of at least 2 m.

The installation of a lightning counter above the protective tube is recommended to perform the verification and maintenance of the facility.

► LPS passive down conductors

In order to reduce the likelihood of damage due to lightning currents circulating in the LPS, down conductors must be arranged so that from the point of impact grounding is:

Protection Level	Distance between conductors
I	10 m
II	10 m
III	15 m
IV	20 m

Table 6 – Distance between down conductors IEC 62305-3.

It is also advisable to place the down conductors on exposed corners of the building whenever constructively possible.

The dimensions and materials of the ground down conductors, must meet the requirements contained in IEC 62561-2 (Table 5).

The conductors that form the mesh must be properly set, taking as reference 1 conductor clamp per meter.

Protect the bottom of the down conductor with a protective tube of at least 2 m.

Install section elements in each of the down conductors to allow for measurement of the ground (see Fig. 12).

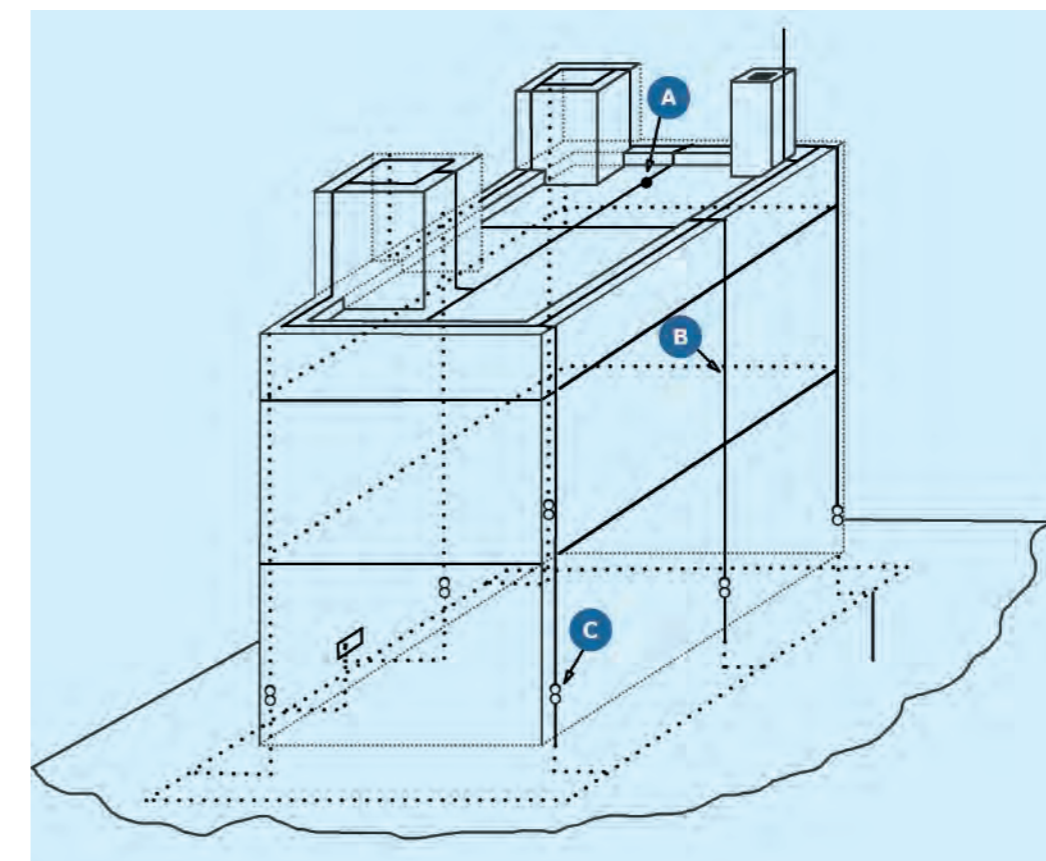

Fig. 12 – LPS passive scheme:
A: Horizontal conductor cover
B: Grounded conductor
C: Down conductor isolator

INGESCO® PDC (ESE) LIGHTNING RODS



Non-expendable
5 year warranty
Natural field trials
UL test
Max. current 200kA
No maintenance
Stainless steel 316 L
UNE 21186:2011
NFC 17-102:2011
NP 4426:2013

Modelo PDC6.4

► technical specifications

Lightning rod with **non-electronic** streaming.

Suitable for external lightning protection of all types of structures and open areas.

- **Level of protection rated very high.**
- **100% effective in discharge.**
- Guaranteed **electrical continuity.**
- **Retains all its initial properties after each discharge so does not require specific maintenance.**
- No batteries or external power. No electronic. **Not fungible.**
- **Operation guaranteed** in any atmospheric condition.
- Made of **AISI 316L** stainless steel and polyamide (PA66).
- **Authentication system** using QR code.

► standards | tests | specifications

INGESCO® PDC, meets the requirements in the following standards:

- CTE SUA 8
- IEC 62305
- UNE 21.186:2011
- IEC 62.561/1
- NFC 17-102:2011
- NP 4426:2013

Evaluation tests of ESE (Annex C UNE 21186: 2011) in the LABELLEC High Voltage Laboratory.

Certificate of current supported IEC 62561/1, issued by the LABELLEC High Voltage Laboratory.

Certificate product issued by the international certification organization Bureau Veritas.

Tested by UL test report number: 4789563988.1.

► coverage radius by protection level

Model	PDC 3.1	PDC 3.3	PDC 4.3	PDC 5.3	PDC 6.3	PDC 6.4
Ref.	101000	101001	101003	101005	101008	101009
Δt	15μs	25μs	34μs	43μs	54μs	60μs
LEVEL I	35 m	45 m	54 m	63 m	74 m	80 m
LEVEL II	43 m	54 m	63 m	72 m	83 m	89 m
LEVEL III	54 m	65 m	74 m	84 m	95 m	102 m
LEVEL IV	63 m	75 m	85 m	95 m	106 m	113 m

Protection radius calculated according to UNE 21.186: 2011, NFC 17.102: 2011 and NP 4426: 2013. (Calculated as a difference in height between the tip of the lightning rods and the considered horizontal plane 20 m.).

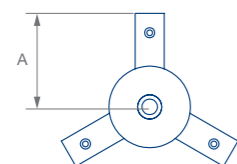
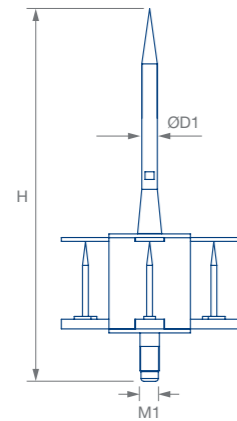

INGESCO® PDC 3.1 LIGHTNING ROD

Coverage radius (m) INGESCO® PDC 3.1 according to protection level and height (UNE 21186:2011, NFC 17-102:2011 and NP 4426:2013)

Ref.	Material	H (mm)	D1 (mm)	M1 (mm)	A (mm)	Weight (g)
101000	SST	380	16	M20	95	2.280

h (m)	LEVEL I	LEVEL II	LEVEL III	LEVEL IV
2	13	15	18	20
4	25	30	36	41
6	32	38	46	52
10	34	40	49	56
20	35	43	54	63

$\Delta t : 15\mu s$
 r: Radius of the rolling sphere
 L-I : r = 20 m
 L-II : r = 30 m
 L-III : r = 45 m
 L-IV : r = 60 m

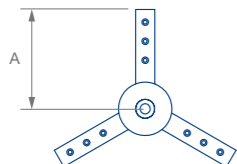
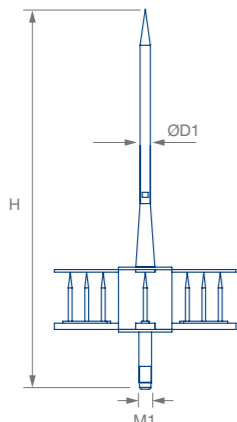

INGESCO® PDC 3.3 LIGHTNING ROD

Coverage radius (m) INGESCO® PDC 3.3 according to protection level and height (UNE 21186:2011, NFC 17-102:2011 and NP 4426:2013)

Ref.	Material	H (mm)	D1 (mm)	M1 (mm)	A (mm)	Weight (g)
101001	SST	554	16	M20	156	3.060

h (m)	LEVEL I	LEVEL II	LEVEL III	LEVEL IV
2	17	20	23	26
4	34	39	46	52
6	43	49	58	66
10	44	51	61	69
20	45	54	65	75

$\Delta t : 25\mu s$
 r: Radius of the rolling sphere
 L-I : r = 20 m
 L-II : r = 30 m
 L-III : r = 45 m
 L-IV : r = 60 m

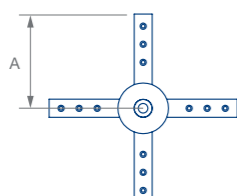
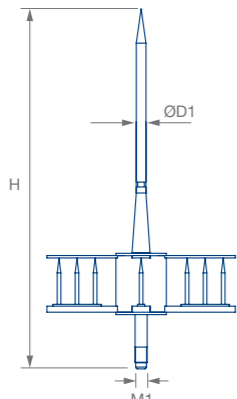

INGESCO® PDC 4.3 LIGHTNING ROD

Coverage radius (m) INGESCO® PDC 4.3 according to protection level and height (UNE 21186:2011, NFC 17-102:2011 and NP 4426:2013)

Ref.	Material	H (mm)	D1 (mm)	M1 (mm)	A (mm)	Weight (g)
101003	SST	554	16	M20	156	3.250

h (m)	LEVEL I	LEVEL II	LEVEL III	LEVEL IV
2	21	24	27	30
4	41	47	54	61
6	52	59	69	77
10	53	61	71	80
20	54	63	74	85

$\Delta t : 34\mu s$
 r: Radius of the rolling sphere
 L-I : r = 20 m
 L-II : r = 30 m
 L-III : r = 45 m
 L-IV : r = 60 m

INGESCO® PDC 5.3 LIGHTNING ROD

Coverage radius (m) INGESCO® PDC 5.3 according to protection level and height (UNE 21186:2011, NFC 17-102:2011 and NP 4426:2013)

Ref.	Material	H (mm)	D1 (mm)	M1 (mm)	A (mm)	Weight (g)
101005	SST	554	16	M20	156	3.460

h (m)	LEVEL I	LEVEL II	LEVEL III	LEVEL IV
2	24	27	31	35
4	49	55	63	70
6	61	69	79	88
10	62	70	81	90
20	63	72	84	95

$\Delta t : 43\mu s$
 r: Radius of the rolling sphere
 L-I : r = 20 m
 L-II : r = 30 m
 L-III : r = 45 m
 L-IV : r = 60 m

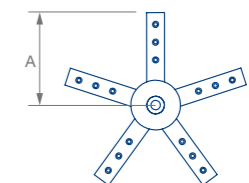
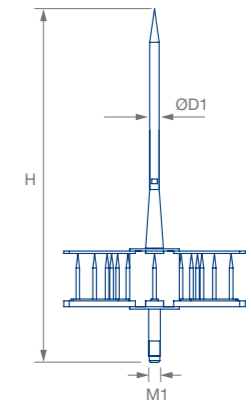

INGESCO® PDC 6.3 LIGHTNING ROD

Coverage radius (m) INGESCO® PDC 6.3 according to protection level and height (UNE 21186:2011, NFC 17-102:2011 and NP 4426:2013)

Ref.	Material	H (mm)	D1 (mm)	M1 (mm)	A (mm)	Weight (g)
101008	SST	554	16	M20	156	3.660

h (m)	LEVEL I	LEVEL II	LEVEL III	LEVEL IV
2	29	32	36	40
4	58	64	72	80
6	73	80	91	100
10	73	82	93	102
20	74	83	95	106

$\Delta t : 54\mu s$
 r: Radius of the rolling sphere
 L-I : r = 20 m
 L-II : r = 30 m
 L-III : r = 45 m
 L-IV : r = 60 m

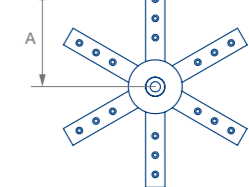
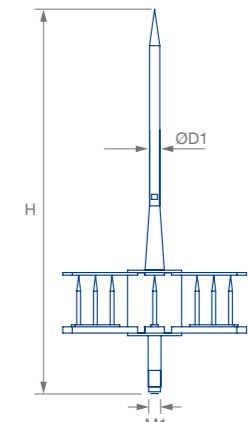

INGESCO® PDC 6.4 LIGHTNING ROD

Coverage radius (m) INGESCO® PDC 6.4 according to protection level and height (UNE 21186:2011, NFC 17-102:2011 and NP 4426:2013)

Ref.	Material	H (mm)	D1 (mm)	M1 (mm)	A (mm)	Weight (g)
101009	SST	554	16	M20	186	4.030

h (m)	NIVEL I	NIVEL II	NIVEL III	NIVEL IV
2	31	35	39	43
4	63	69	78	85
6	79	87	97	107
10	79	88	99	109
20	80	89	102	113

$\Delta t : 60\mu s$
 r: Radius of the rolling sphere
 L-I : r = 20 m
 L-II : r = 30 m
 L-III : r = 45 m
 L-IV : r = 60 m

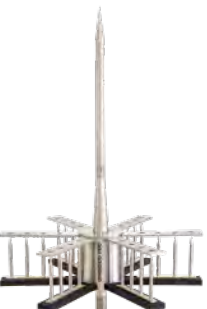
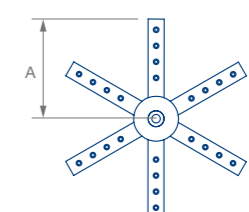
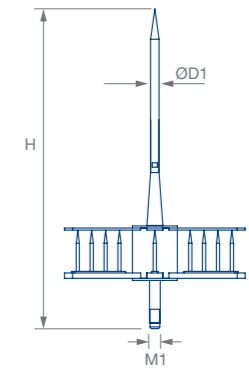

INGESCO® PDC.E LIGHTNING ROD



5 year warranty

Natural field trials

UL Test

Testable

Stainless steel 316 L

UNE 21186:2011

NFC 17-102:2011

NP 4426:2013

► technical specifications

Lightning rod with **ELECTRONIC** streaming.

Suitable for external lightning protection of all types of structures and open areas.

- **Level of protection rated very high.**
- **100% effective in discharge. Maximum durability.**
- Requires no external power source.
- **Guaranteed operation** after lightning strike and in any weather condition.
- Made of **AISI 316L** stainless steel.
- **Authentication system** using QR code.
- **Laser** recording of the information in the head.

► standards | tests | specifications

INGESCO® PDC.E, meets the requirements in the following standards:

- CTE SUA 8
- IEC 62305
- NP 4426:2013
- UNE 21186:2011
- IEC 62561/1
- NFC 17-102:2011
- IEC 62561/3

Evaluation tests of ESE (Annex C UNE 21186: 2011) in the LABELEEC High Voltage Laboratory.

Mechanical test (traction and flexing until breakage).

Certificate of current supported IEC 62561/1, issued by the LABELEEC High Voltage Laboratory.

Certificate product issued by the international certification organization Bureau Veritas.

Tested by UL test report number: 4789563988.1.

► coverage radius by protection level

Model	PDC.E 15	PDC.E 30	PDC.E 45	PDC.E 60
Ref.	102004	102005	102006	102007
Δt	15μs	30μs	45μs	60μs
LEVEL I	35 m	50 m	65 m	80 m
LEVEL II	43 m	59 m	74 m	89 m
LEVEL III	54 m	70 m	86 m	102 m
LEVEL IV	63 m	81 m	97 m	113 m

Protection radius calculated according to UNE 21186: 2011, NFC 17-102: 2011 and NP 4426: 2013. (Calculated as a difference in height between the tip of the lightning rods and the considered horizontal plane 20 m.).

Modelo PDC.E 60

INGESCO® PDC.E 15 LIGHTNING ROD

► Coverage radius (m) INGESCO® PDC.E 15 according to protection level and height (UNE 21186:2011, NFC 17-102:2011 and NP 4426:2013)

Ref.	Material	H (mm)	D1 (mm)	D2 (mm)	M1 (mm)	Weight (g)
102004	SST	412	16	83	M20	3775

h (m)	LEVEL I	LEVEL II	LEVEL III	LEVEL IV	
2	13	15	18	20	Δt : 15μs r: Radius of the rolling sphere L-I : r = 20 m L-II : r = 30 m L-III : r = 45 m L-IV : r = 60 m
4	25	30	36	41	
6	32	38	46	52	
10	34	40	49	56	
20	35	43	54	63	

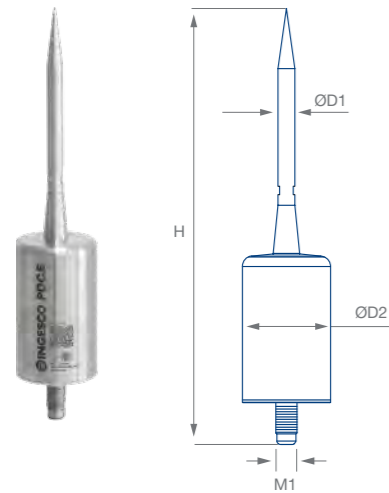

INGESCO® PDC.E 30 LIGHTNING ROD

► Coverage radius (m) INGESCO® PDC.E 30 according to protection level and height (UNE 21186:2011, NFC 17-102:2011 and NP 4426:2013)

Ref.	Material	H (mm)	D1 (mm)	D2 (mm)	M1 (mm)	Weight (g)
102005	SST	412	16	83	M20	3770

h (m)	LEVEL I	LEVEL II	LEVEL III	LEVEL IV	
2	19	22	25	28	Δt : 30μs r: Radius of the rolling sphere L-I : r = 20 m L-II : r = 30 m L-III : r = 45 m L-IV : r = 60 m
4	38	44	51	57	
6	48	55	64	72	
10	49	57	66	75	
20	50	59	70	81	

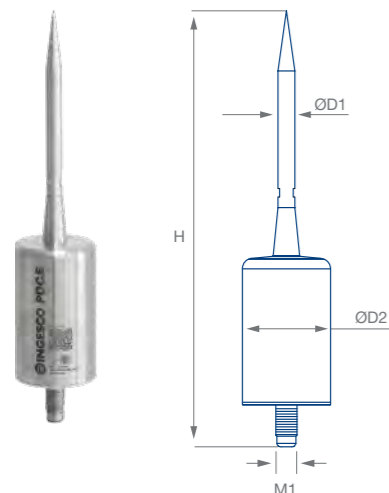

INGESCO® PDC.E 45 LIGHTNING ROD

► Coverage radius (m) INGESCO® PDC.E 45 according to protection level and height (UNE 21186:2011, NFC 17-102:2011 and NP 4426:2013)

Ref.	Material	H (mm)	D1 (mm)	D2 (mm)	M1 (mm)	Weight (g)
102006	SST	412	16	83	M20	3765

h (m)	LEVEL I	LEVEL II	LEVEL III	LEVEL IV	
2	25	28	32	36	Δt : 45μs r: Radius of the rolling sphere L-I : r = 20 m L-II : r = 30 m L-III : r = 45 m L-IV : r = 60 m
4	51	57	64	72	
6	63	71	81	90	
10	64	72	83	92	
20	65	74	86	97	

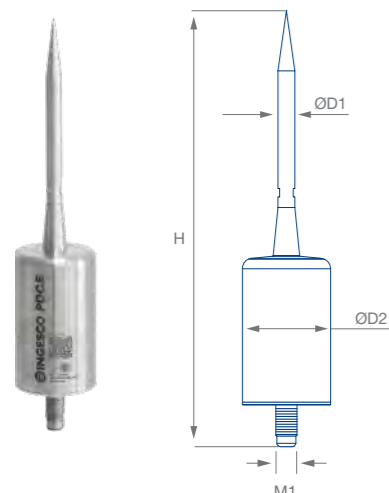

INGESCO® PDC.E 60 LIGHTNING ROD

► Coverage radius (m) INGESCO® PDC.E 60 according to protection level and height (UNE 21186:2011, NFC 17-102:2011 and NP 4426:2013)

Ref.	Material	H (mm)	D1 (mm)	D2 (mm)	M1 (mm)	Weight (g)
102007	SST	412	16	83	M20	3760

h (m)	LEVEL I	LEVEL II	LEVEL III	LEVEL IV	
2	31	35	39	43	Δt : 60μs r: Radius of the rolling sphere L-I : r = 20 m L-II : r = 30 m L-III : r = 45 m L-IV : r = 60 m
4	63	69	78	85	
6	79	87	97	107	
10	79	88	99	109	
20	80	89	102	113	

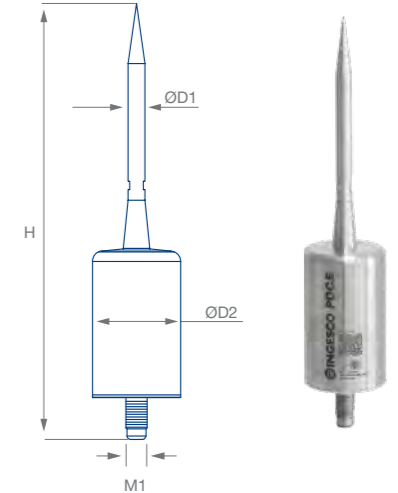

INGESCO ADVANCED ESE TESTER

Ref.	Material	A (mm)	B (mm)	C (mm)	Weight (g)
102051	ABS	89	147	25	320

The INGESCO Advanced ESE Tester is a portable device for testing electronic lightning rods for ohmic contact.

The INGESCO Advanced ESE Tester is designed exclusively for evaluating INGESCO electronic ESE arrester. ESE future electronic models INGESCO and lightning rods from other manufacturers may not be compatible with the technology of the INGESCO Advanced ESE Tester.

► technical specifications

- Temperature range: -10°C to 40°C
- Power consumption: 30mA
- Power: Battery 9V IEC6LR61/IEC6F22/USA PP3
- Test terminals 1m long and 9V battery

